

# THE DEVELOPMENT OF A UAV BASED MMS PLATFORM AND ITS APPLICATIONS

Meng-Lun Tsai<sup>a\*</sup>, Kai-Wei Chiang<sup>a</sup>, Yun-Wen Huang<sup>a</sup>, Cheng-Fang Lo<sup>b</sup>, and Yi-Shiang Lin<sup>b</sup>

<sup>a</sup> Department of Geomatics, National Cheng Kung University, No.1, University Road, Tainan 701, Taiwan, +886-6-2370876 ext.857, taurus.bryant@msa.hinet.net

<sup>b</sup> Geosat Informatics & Technology Co., No.253, 12F, Dongmen Road Sec. 3, Tainan 701, Taiwan, +886-6-335-1068, ceo@geosat.com.tw

**KEY WORDS:** Unmanned Airborne Vehicle (UAV), Global Positioning System (GPS), Inertial Navigation System (INS), Direct georeferencing, Triangulation bundle adjustment

**ABSTRACT:** In order to facilitate the applications such as environment detection, military security, or disaster monitoring, developing a quickly and low cost system to collect near real time spatial information is very important. Such a rapid spatial information collection capability has become an emerging trend in the technology of remote sensing and mapping application. However, there are some advantages and disadvantages with conventional aerial or ground base platforms. In this study, a fixed-wing Unmanned Airborne Vehicle (UAV) based spatial information collection platform is proposed. The proposed UAV based platform has a direct georeferencing ready module including an integrated Global Positioning System (GPS) and Inertial Navigation System (INS), low cost digital camera as well as other common UAV modules including immediately video monitoring communication system, and other sensors mounted on the platform. The preliminarily results indicates that the Ground Sample Distance (GSD) reaches 6 centimeters and 3-D positioning accuracy reaches 10 centimeters when the flight height is 300 meters. Such specification can be applied for 1/1000 topographic mapping. When the flight height is 600 and 900 meters, the GSDs are 17 and 19 centimeters respectively, the 3-D positioning accuracy reaches 23 and 50 centimeters respectively. Furthermore, the proposed platform can be used for 1/2500 topographic mapping application. In addition, they can be applied for producing 1/5000 aerial photo map for national land resources investigation and general navigation applications. Besides, we also conduct the Digital Elevation Model (DEM) by using numerical photogrammetry workstation. The elevation accuracy of the check points is 0.144 meters and the positioning accuracy of x and y axis is 0.049 and 0.027 meters. Moreover, the proposed platform was sent for collecting the spatial information for disaster assessment after devastating Typhoon Morakt that hit southern Taiwan hard during summer 2009. It is also presented in this study.

## INTRODUCTION

As the numbers of devastating disasters increase due to the climate changes taking place recently, developing a quickly and low cost system to collect near real time spatial information is very important. Such a rapid spatial information collection capability has become an emerging trend in the technology of remote sensing and mapping applications. Airborne remote sensing, more specifically aerial photogrammetry, in its classical form of film-based optical sensors (analogue) has been widely used for high accuracy mapping applications at all scales and rapid spatial information collection for decades. Recently the film-based optical sensors (analogue) have been replaced digital imaging sensors.

In general, the necessity for GCPs was so evident that all operation methods relied on it. Even with the major changes in photogrammetry from analogue to analytical and then to the digital mode of operation, it was taken for granted that GCPs were the only source for providing reliable georeferencing information. Only recently has direct georeferencing (DG) become possible by integrating Global Positioning System (GPS) and Inertial Navigation System (INS), such that all the exterior orientation information has become available with sufficient accuracy at any instant of time (Schwarz et. al., 1993). The integration of GPS/INS puts the georeferencing of photogrammetric data on a new level and frees it from operational restrictions. Together with digital data recording and data processing, it initiates the era of multi-sensor systems.

Operational flexibility is greatly enhanced in all cases where a block structure is not needed. Costs are considerably reduced, especially in areas where little or no ground control is available. Current accuracy for commercial systems is sufficient for many mapping applications. The cost and production

efficiency have been improved significantly through using DG based photogrammetric platforms. However, there are some limitations for current DG based photogrammetric platforms. The cost for renting the plane to conduct aerial photogrammetry is high and there are strict regulations and complicated procedures to obtain the permit to conduct flight plan in Taiwan. In addition, the flexibility and capability to conduct small area survey or rapid spatial information collection is rather limited. Therefore, a DG ready airborne platform that is relatively free of government regulations as well as costs less flight expense but maintains high mobility for small area survey or rapid spatial information collection is desired for urgent response such as disaster relief and assessment.

## THE TECHNICAL CONFIGURATIONS OF PROPOSED PLATFORM

The configuration of proposed DG based UAV photogrammetric platform is illustrated in Figure 1. The components of each module are illustrated in details in the following sections.

The proposed UAV platform is illustrated in Figure 2. As indicated in the figure, the proposed UAV is designed for medium range applications. The maximum operational range is 20 kilometers and its real time video transmission range is 20 kilometer with extended range communication links. The flexible flight altitude and two hours endurance time make it a suitable to small area and large scale photogrammetric mission.

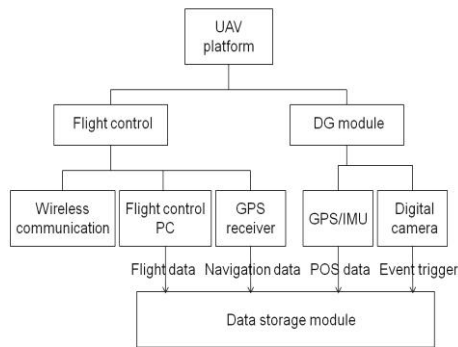

Figure 1 The configuration of proposed DG ready UAV photogrammetric platform



Figure 2 The specifications of proposed UAV platform

Figure 3 depicts the DG module designed in this study to facilitate GCP free photogrammetry as well as INS/GPS POS aided bundle adjustment. The data storage module used to record the measurements collected by IMU(MMQ-G), GPS(AEK-4T) as well as synchronized time mark used to trigger Camera(Canon 450D) is Antilog from Martelec. Due to the limitations of payload and power supply, a PC or notebook based data storage module is ruled out. Therefore, a simple mechanization that can store measurements communicated through serial ports is desired. Therefore, Antilog is chosen because of its unrivalled flexibility, low power consumption, and reliability. Similarly, since EOS 450D has its own storage mechanization, it is not included in this module.

Figure 4 illustrates the set up of the DG module within the UAV platform. As shown in this figure, the MMQ-G is set center on top of the camera. The nominal location of GPS antenna is in the left compartment.

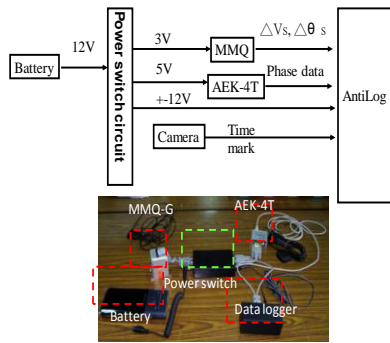

Figure 3 The configuration of DG module

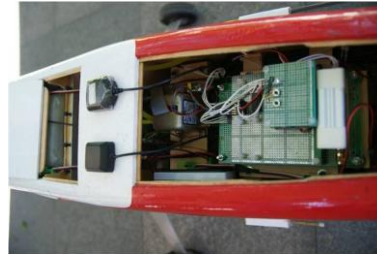

Figure 4 The set up of DG module in UAV

## THE DATA PROCESSING STRETEGY

Figures 5 (left and right) illustrates the INS/GPS POS assisted AT based photogrammetric process and DG based photogrammetric process implemented in this study, respectively.

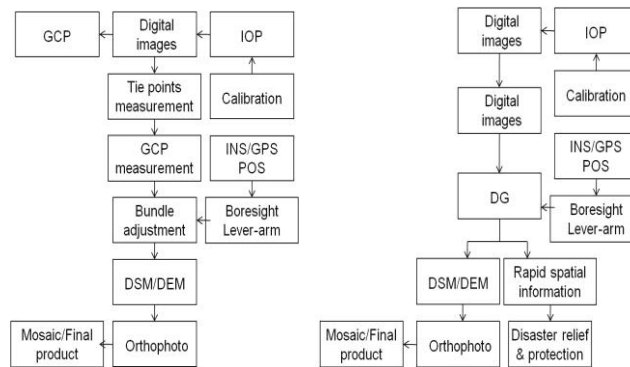

Figure 5 (left)The proposed INS/GPS POS assisted AT based photogrammetric process (right)The proposed DG-ready photogrammetric procedure

Post-mission processing, when compared to real-time filtering, has the advantage of having the data of the whole mission to estimate the trajectory (Shin and El-Sheimy, 2005). This is not possible when using filtering because only part of the data is available at each trajectory point, except the last. When filtering is used in the first step, an optimal smoothing method, such as Rauch-Tung-Striebel (RTS) backward smoother, can be applied (Chiang et. al., 2004). It uses the filtered results and their covariances as a first approximation. This approximation is improved by using additional data that was not used in the filtering process. Depending on the type of data used, the improvement obtained by optimal smoothing can be considerable (Gelb, 1974).

For georeferencing process which puts POS stamps on images and measurement process that obtains 3-D coordinates of all important features and stores them in GIS database, only post-mission processing can be implemented based on the complexity of those processes (El-Sheimy, 2002). Therefore, most of the commercially available DG systems operate in real time only for data acquisition and conduct most of the data processing and analysis in post-mission mode. Figure 6 illustrates the loosely coupled INS/GPS integrated scheme implemented in this study.

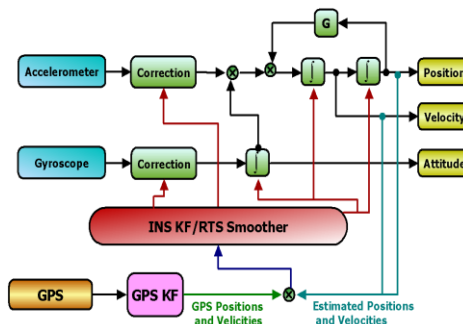

Figure 6 The loosely coupled INS/GPS integrated scheme

## RESULTS AND DISCUSSIONS

To validate the performance of proposed platform, a field test was conducted in the winter, 2009. The area of the test zone is 3km\*3km, which is covered by the red square shown in Figure 7. The blue region illustrated the fly zone approved for this test. This region is chosen because it is composed complicated landscapes including a township, farms, traffic networks and rivers. Most important of all, this area is covered with intensively distributed GCPs that can be applied for bundle adjustment process as well as the checking points used for performance validation.



Figure 7 The proposed DG-ready photogrammetric procedure

### Flight planning

The flight altitudes set for aerial photography is 1200 meters, 900 meters, 600 meters and 300 meters above ground, respectively. Owing to the limit of the payload and the impact of side wind affecting the attitude of UAV, the endlap and sidelap were increased to 80% and 40% respectively to insure that the coverage of the stereo pair can overlap completely during the test flight. Although more images have to be processed, it can be guaranteed that the completed coverage of the stereo pair.

### INS/GPS POS results

Figure 8 illustrates the trajectory of POS solutions during two of those tests. In this study, the INS/GPS integrated POS solutions were applied to assist bundle adjustment, as shown in Figure 5. The latitudinal trajectory is with 300 meters flight altitude and longitudinal trajectory is with 600 meters flight altitude, respectively. The lower rectangular shows the track of UAV's maneuver of raising the altitude and check in to the flight path for photogrammetry. The upper rectangular shows the track of UAV's maneuver when a long GPS outage took place. Therefore, the images took during this period of time were not used in this study.



Figure 8 The trajectory of integrated POS

### Photogrammetric results analysis

The area of the test zone set for the scenarios with 1200 meters, 900 meters and 600 meters altitude is 3km\*3km and that for the scenario with 300 meters altitude is 800m\*600m. The preliminary results indicate that the GSD reaches 6 centimeters and 3-D positioning accuracy reaches 10 centimeters when the flight height is 300 meters. Such specification can be applied for 1/1000 topographic mapping. When the flight heights increase to 600 and 900 meters, the GSDs are 17 and 19 centimeters respectively, the 3-D positioning accuracies reaches 23 and 50 centimeters respectively. Furthermore, the proposed platform can be used for 1/2500 topographic mapping application. In addition, they can be applied for producing 1/5000 aerial photo map for national land resources investigation and general

navigation applications. In addition, Table 1 depicts the numerical performance of those orthophotos with respect to check points from different scenarios. Figure 9 depicts the orthophoto of the test area when the flight altitude is 600 meters.

Table 1 The accuracy of orthophotos from different scenarios

Item	X(m)	Y(m)	XY(m)
1200m	0.39	0.32	0.51
900m	0.39	0.35	0.52
600m	0.35	0.32	0.47



Figure 9 The comparison of orthophotos from different scenarios

Besides, the Digital Terrain Model (DTM) is generated by using numerical photogrammetry workstation. The first step is to match the elevation with image and interpolate the contour. Then, the elevation model is rectified by overlaying the stereo pair of image and iterative calculation to complete the DTM. Finally, the orthophoto and 3D model of the test area are produced, as shown in Figures 10 and 11. The elevation accuracy of the check points is 0.144 meters and the positioning accuracies of x and y axis is 0.049 and 0.027 meters, respectively. Figure 12 illustrate the detailed data processing strategy of proposed system to generate topographic map, DTM, fusion of DTM and images, and orthophoto.

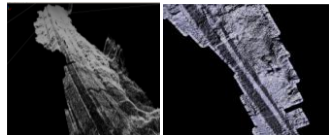

Figure 10 The Digital Terrain Model (DTM) results

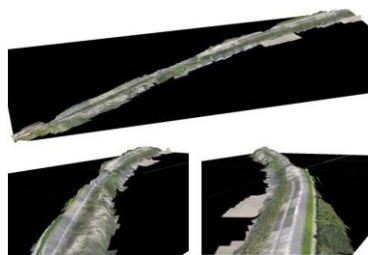

Figure 11 The 3D model results

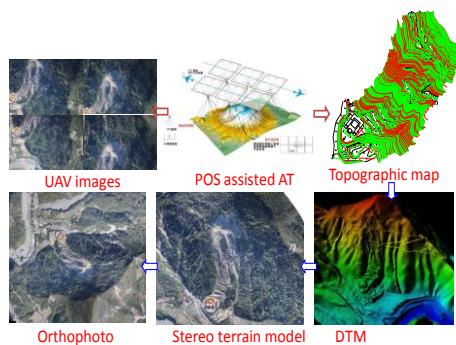

Figure 12 The detail of data processing strategy

Moreover, the proposed platform was sent for collecting the spatial information for disaster assessment after devastating Typhoon Morakht that hit southern Taiwan hard during summer 2009. Figure 13 compares the change of landscape due to the flood and landslide triggered Morakht typhoon. Those images can be applied to analysis the place where occurred changing of terrain, or collapsing of slope. The bottom of Figure 16 illustrates the location where a mudslide buried the entire town of Xiaolin in southern Taiwan killing an estimated five hundred people in the small town alone.

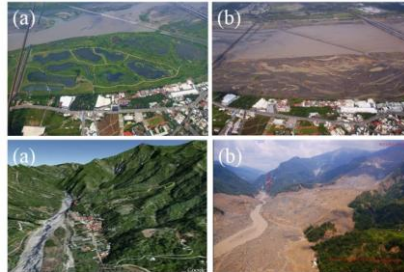

Figure 13 (a) before (b) after typhoon Morakht during summer 2009

The performance verification process indicates the proposed platform can capture the aerial images successfully fulfilling the requirements of different tasks. With the proposed low cost but high mobility direct georeferencing ready UAV based platform, the efficiency and expanse of certain photogrammetry can be significant improved without sacrificing too much positioning accuracy. In addition, the direct georeferencing ready function of proposed platform guarantee the mapping and positioning capability even in GCP-free environments, which is very important for rapid urgent response for disaster relief.

## CONCLUSIONS

The performance verification process indicates the proposed platform can capture the aerial images successfully fulfilling the requirements of different tasks. With the proposed low cost but high mobility direct georeferencing ready UAV based platform, the efficiency and expanse of certain photogrammetry can be significant improved without sacrificing too much positioning accuracy. In addition, the direct georeferencing ready function of proposed platform guarantee the mapping and positioning capability even in GCP-free environments, which is very important for rapid urgent response for disaster relief. Therefore, the future works of this study is to implement a direct georeferencing based UAV disaster relief platform that can perform a large scale and small area rapid map production in disaster area with the support of direct georeferencing based rescue missions.

## REFERENCES

- Chiang, K.W., Noureldin, A. and El-Sheimy, N., 2004. A New Weight Updating Method for INS/GPS Integration Architectures Based on Neural Networks. *Measurement Science and Technology*, 15 (10), pp. 2053-2061.
- Gelb, A., 1974. *Applied Optimal Estimation*. The Analytic Science Corporation.
- El-Sheimy, N., 2002. Introduction to Inertial Navigation. Geomatics Department, University of Calgary, ENGO 699.71 lecture notes.
- Schwarz, K.P., Chapman, M.E., Cannon, E., and Gong, P., 1993. An Integrated INS/GPS approach to the georeferencing of remotely sensed data. *Photogrammetric Engineering & Remote Sensing*, 59 (11), pp. 1667-1674.
- Shin, E.H. and El-Sheimy, N., 2005. Navigation Filter Design for Pipeline Pigging. *Journal of Navigation*, Cambridge University Press, 58, pp. 283-295.

## ACKNOWLEDGMENTS

The author would acknowledge the financial support by the National Land Surveying and Mapping Center, Ministry Of The Interior, ROC (Taiwan) (NLSC-97-28). From his supervisor, Dr. Kai-Wei Chiang, who initially encouraged him to apply and by given him the time and resources needed for helping him accomplishing this work. Dr. Cheng-Feng Lo and his colleagues from GeoSat Informatics Technology Co and Dr. Chung-Hui Wu from Skyline Dynamics Co. are acknowledged for the development of UAV platform as well as their assistance conducting the test flight.