

ANALYSIS OF KEYHOLE TOMB-LIKE TOPOGRAPHY OF ORONO-SHIMA ISLAND — ORIGINS OF THE ANCIENT TOMB SYSTEM IN JAPAN? —

Yamaguchi Tetsuya¹ and Susumu Ogawa², Moriyama Toshiyuki³, Taniguchi Yukiya⁴, Shiraiishi Haruhiro⁵

¹ Fukuoka Institute of Technology, 3-30-1 Wajirohigashi, Higashi-ku, Fukuoka City, Fukuoka 811-0295
Email: onogorotarou0416@gmail.com

² Institute of Spatial Technology, Toyo3-1-5, Koto, Tokyo 135-0016
Email: ogawa_susumu_phd@yahoo.co.jp

³ Fukuoka Institute of Technology, 3-30-1 Wajirohigashi, Higashi-ku, Fukuoka City, Fukuoka 811-0295
Email: todora@palau.net

⁴ The University of Tokyo, 7-3-1 Hongo, Bunkyo-ku, Tokyo 113-8654
Email: taniguchi-yukiya312@g.ecc.u-tokyo.ac.jp

⁵ Ministry of Agriculture, Forestry and Fisheries, 1-2-1 Kasumigaseki, Chiyoda-ku, Tokyo
Email: ryoma.haruhiro@gmail.com

KEY WORDS: Archaeology, Topography, Regional geography, Geographic information system, Remote sensing

ABSTRACT: Orono-shima Island is a remote Island in the Tsushima Strait, it is 4.3km around. Since ancient times, it has been a landmark when crossing from the Korean Peninsula to Japanese archipelago via Tsushima Island and Iki Island. However, large-scale ruins and burial mounds are not known on Orono-shima Island until now. During my four years on the island, the author walked all over the island for terrain survey. As a result, the author discovered a topography like keyhole tomb which is a characteristic Japanese burial mound, on the northern cape of the island. It could be up to 150m in size, one of the largest around Kyusyu Island. There is no burial mound comparable to this on a remote island in Japan. Therefore, we created a 3D image using a drone photograph of this terrain and we compared the results with another keyhole tomb. In addition, we analyzed the image of infrared radiation of Orono-shima Island took by Landsat8. In conclusion, it was speculated that this topography was the prototype of the oldest type of keyhole cairn tomb in Japan. The topography of the northern part of Orono-shima could be regaining the missing link between the cairn on the Korean Peninsula of the first century and the oldest type of keyhole cairn tomb in Japan of the third century. By the way, the keyhole tombs were a grave system of the ancestor of the emperor family, and the emperor family is the oldest royal family in the world which inherits the Japanese myth. Therefore, if the topography of the northern part of Orono-shima Island was the founder type of keyhole tomb, Orono-shima Island might be Onogoro-shima Island that was the first land to appear in Japanese mythology.

1. INTRODUCTION

1.1 Orono-shima history



Fig.1 Genkai-nada sea area and Orono-shima Island
(picture from yahoo map modified by T.Yamaguchi)

It is a 12th century record that Orono-shima Island first appeared in ancient documents (Yanagi 1995). However, it is certain that the Genkai-nada sea area where Orono-shima Island is located was a sea-course to "Yamatai-koku" country, which was recorded in the history of China in the 3rd century (Sakamoto & G. Cameron Hurst). It has always been the gateway of Japan from ancient times, and it is a sea area that has been greatly related to the history of Japan. The Nabatake Ruins at Saga Prefecture and the Itazuke Ruins at Fukuoka Prefecture are located along the coast of the Genkai-nada Sea, and they were Japan's first rice cultivation sites in the

early Yayoi era.

The remains in Ito-koku country where are on the coast of the Genkai-nada Sea had luxurious burial items that show interaction with the Han Dynasty at the 1~2nd century.

In addition, there are Okino-shima island and Aino-shima Island in Genkai-nada sea. Okino-shima Island was registered as a World Heritage Site in 2017. It's because that island's ancient rituals were held by the Japanese Emperor between the 4th ~ 10th centuries. The oldest of the God's Notice recorded in Japanese mythology related this island. Aino-shima Island is famous for its crowd cairn tombs which were built in the 4~7th centuries. Cairn tomb was not common in Japan, but it was a very common grave system on the Korean Peninsula.

These facts are clearly indicating that this area was a culturally advanced part of Japan from ancient times. Orono-shima Island is in the center of it, and it is easy to imagine that it has become an important point of transportation.

1.2. Keyhole tomb

Keyhole tombs are said to be the shape of burial mound unique to Japan, and it is widely distributed in Japan (Ogata 2019). It has a unique shape with a square protrusion by the hill of the round. In addition, there are various ways to write when writing in English. Therefore, in this paper, it is written uniformly by "keyhole tomb". It is believed that 5,200 tombs were built from the middle of the 3rd century to the 7th century (Hirose 2009). There is a tendency to shape by the era, and there are several lineages. In general, the short protrusions of the squares are old tombs.

Some of the round tomb of the Yayoi era before the kofun era, there is a form that surrounds the moat. Among them, there is a land bridge that crosses the moat. There is a study that this land bridge is cut off from land and surrounded by the moat is the origin of the keyhole-tomb.

However, the prototype of the keyhole tombs is not known, and various candidates have been given. On Kyushu Island, keyhole tombs appeared along the coast of the Genkai-nada sea from the early Kofun era (Yanagisawa 2003-2004). In the past, it has been interpreted that the keyhole tombs of the old type had a grave system with a unified shape as a proof recognized by central politics. However, a unique old-style shape that can be said to be a Kyushu type has also been confirmed recently (Fukuoka City Buried Cultural Properties Division 2019).

1.3. Keyhole tomb facing the sea

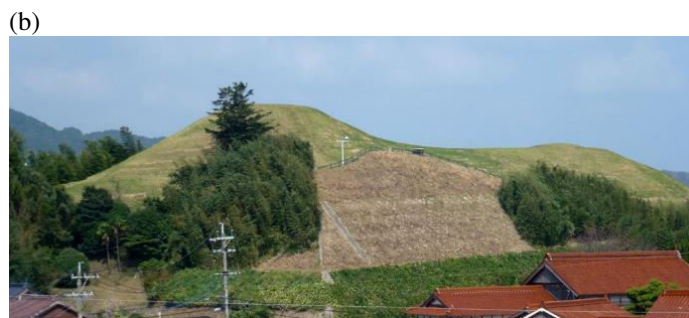
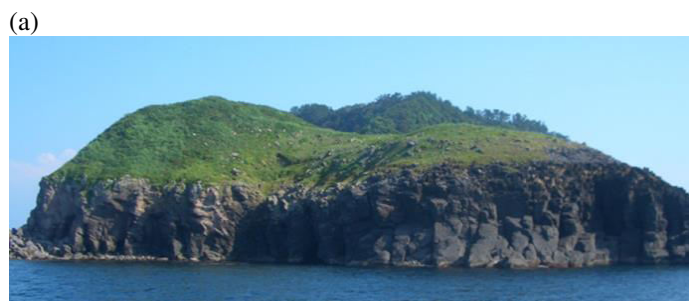

Fig.2 Northern topography of Orono-Island as seen from the sea on the north side and example of early keyhole-tomb.

(Kurisouzui-Kofun(108m) : Karatsu City, Saga Prefecture)
(photographs taken by the author)

A recent study summarized the characteristics of keyhole tomb (including large round burial mounds) made in mountains and hills facing the sea, or on lands and beaches (Hirose 2015). It has the coastal nature of looking up from the shoreline and looking down at the sea, and many were found on the coast of land, but they were few built on islands. As previously thought, the understanding that a huge keyhole tomb was built on the plain using surplus labor of rice field cultivation with high productivity does not apply to the keyhole tomb facing the sea. In many cases, the burial mound facing the sea does not have a stable lineage like the tomb of the chief of the plain, and there are usually huge one-time tomb. " Instead of seeking the power base of the chief who created a sea-facing keyhole tombs in a narrow area near the coast, it seems better to consider a wide area from the coast to the inland far away" (Hirose 2015). In other words, they were often created one-off by huge power and financial power when the bays and beaches had political importance.

Fourteen such keyhole tombs were also listed along the Coast of the Genkai-nada Sea

(Kasiwagi 2015). One of them is Kurisouzui Kofun (See Fig2(b)). It looks like northern Orono-shima topography (Fig2(a)). Among them, only Tsushimazuka-tomb (63m) and Soroku-tomb (91m) on Iki Island exist on remote islands. In Japan as a whole, 11keyhole tombs on small remote islands were listed, including Takeshima-tomb (56m)

in Yamaguchi Prefecture and Kuroshima-tomb (81m) in Okayama Prefecture (Kasiwagi 2015). However, all of them are located within 3 km of land. If tomb was exceeding 100 m and built on a remote island 30 km away like Orono-shima Island, this is a unique example in Japan.

1.4. Cairn Tombs

Cairn tomb is an ancient burial mound in which the mounds are piled up with stones. The area where this tomb form exists during the Kofun era is biased. There are well-known that About 500 of them are in the Omuro cairns Kofun Group in Nagano Prefecture, the Aino-shima cairns Kofun Group in Fukuoka Prefecture which located 254 in the 400-meter-long seaside area, the Iwaseoyama Kofun Group in Kagawa Prefecture with about 200, and the Mishima Gee combo Kofun Group in Yamaguchi Prefecture which has about 200 tombs. It is also found in some areas in northern Shikoku Island, Nagano prefecture, and some areas of Yamanashi Prefecture.

In the northern part of Shikoku Island was mainly built about 3rd~4th centuries, and the oldest of the Iwaseoyama kofun group in Kagawa Prefecture is Tsuruo Shrine No. 4 burial mound. Some studies have thought that it is the oldest of the Japanese keyhole tomb from the age of the earthenware that was buried (Watanabe 1983).

Cairn Tombs in Nagano and Yamanashi Prefecture were formed between the 5th~6th centuries. However, the oldest tomb in the Nagano valley is Mori Shogun zuka tomb (100m) located 11km southwest of the Omuro Kofun Group. This is not a masonry mound, but it is considered to be a keyhole tomb built at the end of the 4th century with a large amount of stones on the surface.

There is a theory that Cairn Tombs used stones near them instead of soil in the absence of soil. However, the keyhole-shaped Cairn Tombs found in the northern part of the Korean Peninsula, there is also the idea that it is related to the person who came to Japan. In the official documents of the 9th century, the horse farm "Omuro-maki" near the Omuro Kofun group was described. It has been pointed out that this may have something to do with horse grazing, which has been imported from Korea since the 5th century and spread rapidly in Japan (Nagano City Board of Education 2015).

2. METHODS

2.1. Ground survey



Fig.3 Rock accumulation in the northern terrain of Orono-shima Island. (Photograph by the author)

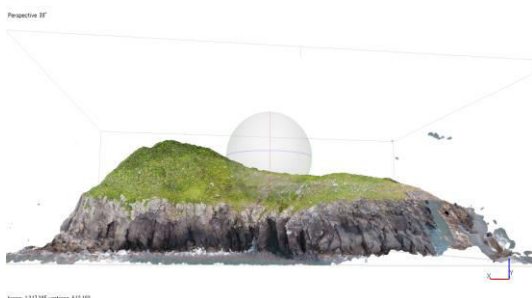

Fig.4 3D image of the northern topography of The Orono-shima Island (from north).

The topography in the northern part of Orono-shima Island is located at the tip of Island, surrounded by the sea in the west, north, and east, and looks like a keyhole tomb that exists on a 10m cliff when viewed from the northern sea (See Fig2(a)).

From the On-the-ground research, it seemed that there was a possibility of the keyhole tomb of cairn which was shaped by piling up a man-sized rock mass in the natural topography. (See Fig.3)

The total length may be up to 150m, and it may be a huge burial mound like no other on a remote island. The east side of the round fell directly into the sea, but the northwest side connected to a flat part thought to be a square part, and there seemed to be a two-stage terrace as a whole. On the south side, there were two stone wall about 1m to 2m wide along the front, and it seemed to form of the terrain which looked like a part of the moat.

Near the top of the round, there is a large recess that looks like a trace of a dug-in coffin. There was also a plate-shaped megalith nearby that seemed to be a lid stone.

The topography has a feature which looks like keyhole tomb as a whole, however the area is overgrown with trees, and the scope of on-site surveys by the author's was limited.

2.2. 3D image creation

As far as aerial photographs were seen, the northern topography of Orono-shima Island seemed to resemble the shape of Tsuruo Shrine No. 4 Kofun tomb and Mori Shougunkzuka Kofun tomb. Therefore, we tried to investigate the creation of a three-dimensional image by taking a picture using a drone from the sky. We obtained about 300 images of the northern terrain of Orono-shima Island. From this image, we created a DEM and ortho aerial photograph using the 3D image software "Meta Shape". (See Fig.4)

2.3. Contour diagram creation

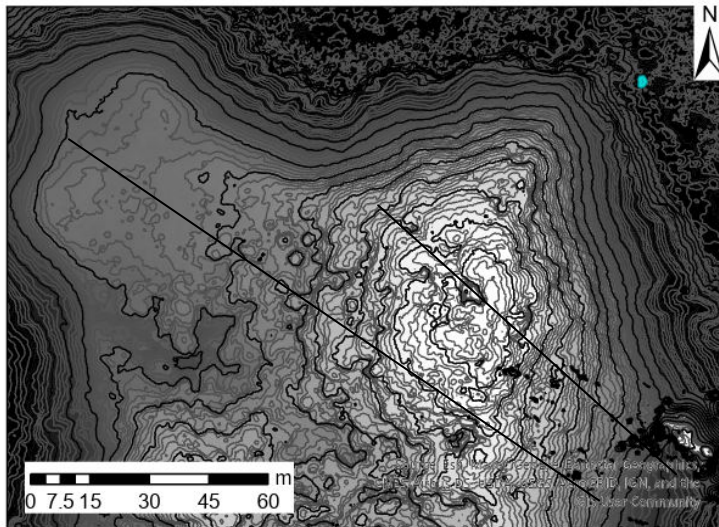

Fig.5 0.5m · 2.5m contour map of the northernmost terrain of Orono-shima Island.

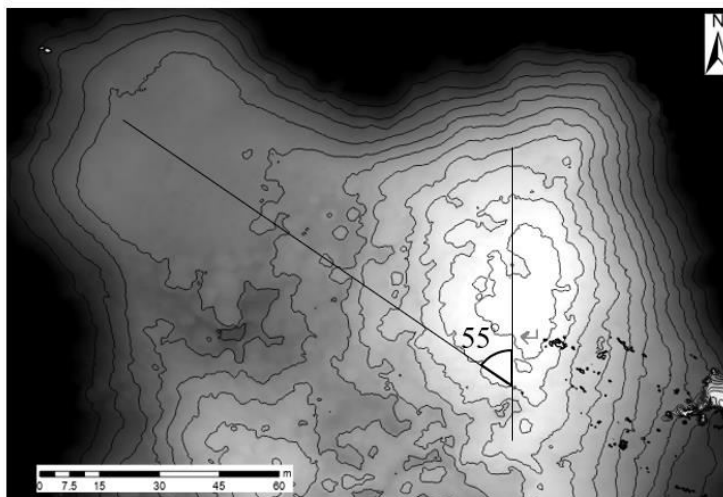

Fig.6 Crossing the main axis of the front square part and rear round part when the northernmost topography of Orono-shima Island was used as the keyhole tomb.

Next, the data of the three-dimensional image of the northern island topography created by "Meta shape" was processed with the map survey analysis software "ArcGIS Pro", and a contour diagram was created. (See Fig.5)

Contour diagram created a 2.5m contour diagram and a 0.5m contour diagram so that the overall picture of the northern terrain of Island and the enlarged image of the rounded hill were compared. (See Fig.6)

However, it should be noted that the contour diagram captured the canopy of the plant in the 3D photograph, and it is not the ground surface.

2.4. "Landsat8" Infrared Image Analysis

The northern topography of Orono-shima Island is composed of rocks. The rock part shows the shape of the keyhole burial mound, but because it is covered with trees, it is not possible to clearly distinguish the rock part from the soil part from the aerial photograph or the contour map diagram.

Therefore, we analyzed an image of Landsat8 that can capture far infrared rays issued by rocks. The image used was taken with Band 10 THIRS 1 (10.6 - 11.19 μm). However, Landsat's Band10 has a resolution of 100m, so it doesn't have enough resolution. Therefore, four images taken on different days (2013.9.27, 10.29, 2015.4.26, 11.5) were synthesized to create an average image, and make up for the lack of resolution by emphasizing the slight difference in radiation by the image analysis software "imageJ". All images were taken between 1:52 ~ 54 when after sunny day for three days, these images seem to match the state of the ground surface and the far infrared radiation tendency well.

3. RESULTS

When the northern topography of Orono-shima Island is a keyhole tomb, it can be roughly analyzed as follows.

3.1. Overview of northern topography

The round is an oval shape centered on the north and south at the highest point altitude of 32 meters, about 45 meters north-south and 30 meters east-west. At an altitude of around 25m, the south side of the round is connected to the ridgeline that crosses the north and south of the island.

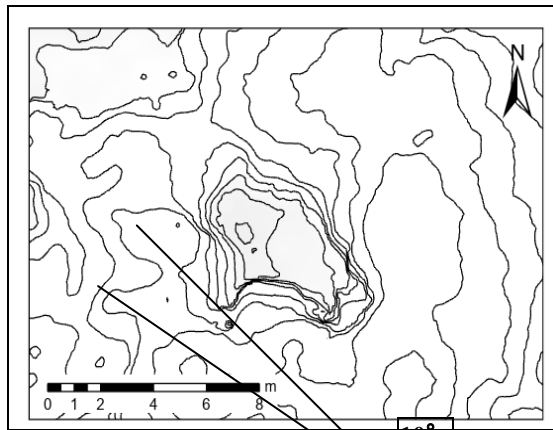

Fig.7 Spread 0.5m contour map of the top of rear round part. The crossing angle is 10° (vs. square part)

Mori Shogun zuka tomb in the Nagano Prefecture, which has the largest pit stone chamber in Japan (See Fig.11).

However, a part of the round is incompletely shaped by the southern peak. The square part direction is approximately N55W at the tip. If the plane at an altitude of 12.5m is the tip of the square part, the total length may be 145m. (See Fig 6)

The northern terrain of Orono-shima island does not match the axis of the oval round and the square part and intersects at an angle of about 55 degrees. This is a unique shape as a keyhole tomb.

3.2. Pit stone chamber-shaped topography

In the center of the rear round (altitude 40m), you can see the topography that seems to be a burial part of a pit-type stone chamber. The sizes are 7m in length, 2.5m in width, 2~2.5m in depth, and N45W in direction. It intersects the main axis of the burial mound at 10 degrees. (See Fig.7).

If this is a pit-type stone chamber, its scale is comparable to

3.3. Other structures

On the northern topography of Orono-shima island, the two clear terraces and the south side stone wall and moat-like topography along the front were unclear and could not be confirmed by the contour diagram.

3.4 Far Infrared Images

From the analysis of the image, we were able to grasp the characteristics of the place where the surface temperature was high.

Residential areas and ports in the south were particularly hot because most of them are covered with concrete. Next, the center of the island was also seen in the high temperature area, but since there is a school here, the temperature of the large sports ground is high.

It is noteworthy that it should be covered with trees, but only the cape part in the north has a high temperature. Moreover, its shape was looks like a keyhole tomb. (See Fig.8)

Despite being covered with trees, the higher temperature than other places were considered to that the surface of the ground is composed only of rocks here. The rocky part of the ground surface has more heat than the soil part. This is consistent with the results of my field survey that the keyhole tomb-like topography of the cape is covered with rocks.

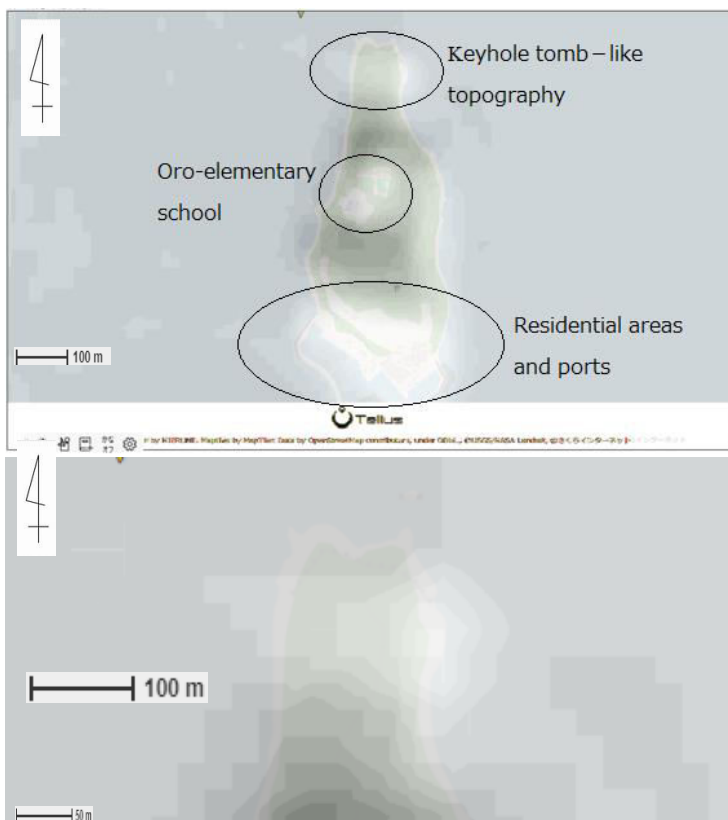

Fig. 8 Composite image of far infrared image and Orono-shima Island map. (*Note that the resolution is 100m)

4. DISCUSSTION

Based on the author's on-site inspection and Results, we thought that the northern terrain of Orono-shima island was a cairn (composed of rocks) type keyhole tomb. Although it has a unique shape as a keyhole tomb, it was found that there were a few keyhole tombs with a shape like this

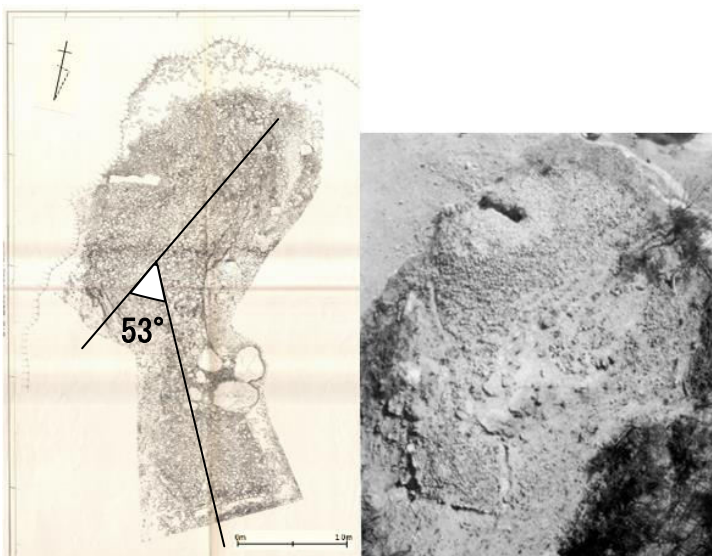

Fig.9 Tsuruo Shrine No. 4 tomb plan and aerial photography
(Image Copyright 2020 Takamatsu City Board of Education)

was 40m. On the other hand, it was estimated that if based on the rear round subordinate stage, the front part was 21.3m, the rear round part was 25.3m, and the total length was 46.6m (Watanabe 1983b).



Fig.10 Aerial photographs of Mori Shogun zuka Kofun
(from Yahoo Map)

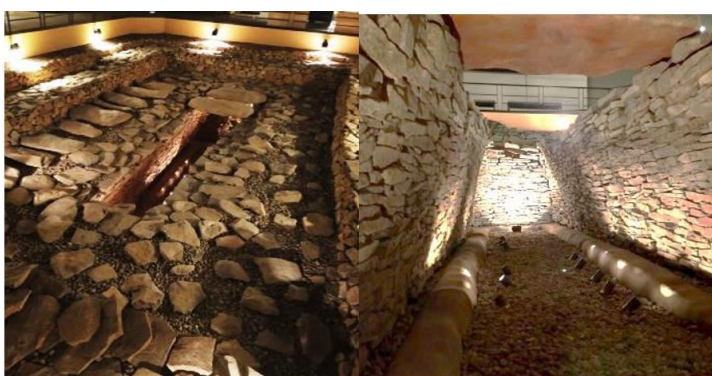

Fig.11 A full-scale model of the pit-type stone chamber of Mori Shogun zuka tomb.
(Image Copyright 2020 Mori Shogunzuka Kofun museum)

topography. Therefore, we will consider it while comparing with these.

4.1 Comparison of shapes with other keyhole tombs

4.1.1. Shape comparison with Tsuruo Shrine No. 4 tomb

Tsuruo Shrine No. 4 tomb is not only the oldest of the Iwaseoyama Kofun Group of cairn type, but also the oldest keyhole tomb in Kagawa Prefecture, and it is thought that it may be one of the founder types of the keyhole tombs afterwards. (See Fig.9)

Its total length was 40 m, and it had a pit stone chamber. It is located on the edge of a cliff in a quarry, and the shape of the rear round part cannot be restored because it partially collapsed. If the upper part of the rear round represents the original burial tomb scale, the front part was 21.3m, the rear round part was 18.7m, and the total length

This research report assumed that the rear round was completely circular from contour figure, and the burial part was in the center (Watanabe 1983b).

However, as far as the survey diagram is observed, the main axis of the square part and the rear round part seems to intersect greatly diagonally.

As far as Fig.9 shows, the square part shows N27°W, and the rear round part seems to show N26°E when it considered to be oval. In other words, the main axis of the rear round is tilted about 53° east of the square part. In the keyhole tomb-shaped topography of Orono-shima, the main axis of the rear round part seems to be tilted almost 55° east of the square part (See fig.6). These values are based on estimates, but they are very close.

4.1.2 Comparison of shapes with Mori Shogun Tsuka tomb

It is the keyhole tomb in the Nagano Valley and was built at the tip of a ridge overlooking the Nagano Valley. It is an ancient tomb decorated with a large amount of rock on the surface. About 10km northeast of there, the Omuro Kofun Group which has the largest number of 500 cairn tombs in Japan exist.

This tomb was built in the early Kofun period (the end of the 4th century), the earliest of the keyhole tomb in Nagano Prefecture and this is considered to be the tomb of the head of the ancient Shinano country which was in the Nagano valley. Because it is on a narrow and

steep ridge at a height of 130 – 140m from the plain, the rear round becomes like an ellipse, and the main axis intersects diagonally by 20 degrees in the square part and the rear round part. According to the research report, it may have been a design plan with a square part of 34m, a rear round of 58m, and a total length of 92m (Morishima 1985). (See Fig.10.12)

In addition, it has been reported that three other keyhole tombs in Nagano valley also use ovals in the rear round (Morishima 1985).

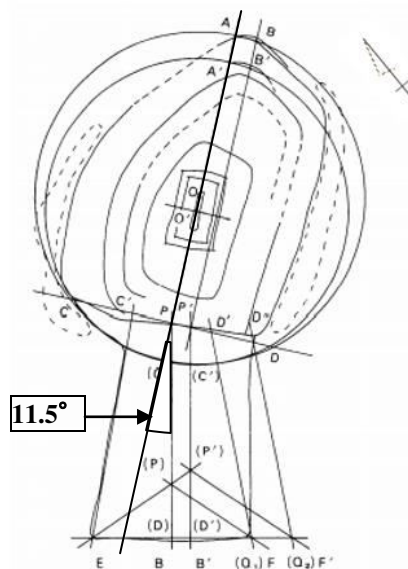

Fig.12 Mori Shogun zuka Kofun Design Planning
Forecast (from Morishima 1985)

4.2. Burial department format and its direction

The burial part in the center of the tomb is an important facility where the thoughts of the buried person appear most. In the form of this burial part, both burial mounds are pit-type stone chamber, and it also looks like a pit-type stone chamber which is top of the topography in the northern part of Orono-shima Island too. The scale seems to be the same scale as that of Mori Shogun zuka Kofun, and this size is the largest pit stone chamber in Japan. (See Fig.11)

In addition, the inclination of the pit stone chamber of the burial part of Mori Shogun zuka Kofun tomb to the main axis (A-P) and the square part of main axis (P-B) is 11.5°E. (See Fig.12)

This is almost in agreement with the Orono-shima kofun topography which of the inclination at 10°E of the pit-type stone chamber topography axis and the square part main axis. The pit stone chamber of Tsuruo Shrine No. 4 tomb is 70% of the structure of Orono-shima with total length and height. In particular, Mori Shogun zuka tomb had many similarities to the Orono-shima topography in scale, with its main axis tilt and stone chamber scale. (See Table 1)

Table 1 Similarities between the northern topography of Orono-Island and the three tombs.

	Northern Terrain of Orono-shima Island	Tsuruo Shrine 4th Kofun tomb	Mori Shogunzuka Kofun tomb	Unpyonri District 4 No. 6 tomb
Location	Genkai Sea area, Fukuoka Prefecture (Northern Kyusyu Island in Japan)	Takamatsu City, Kagawa Prefecture (Northern Shikoku Island in Japan)	Chikuma city, Nagano (Central part of Honsyu Island in Japan)	Jagang-do, North Korea (Near the Korean Peninsula and the border with China)
Scale and type / time	150m cairn keyhole tomb/ ?	40m cairn type/ end of the AD 3rd c.?	100 m keyhole / AD 4th c.	22.5m/ BD1-AD2nd c.
Designation	Un-investigated	National Historic Site (Added to "Iwaseoyama Kofun Group" on August 14,1989)	National Historic Site (March 16, 1971)	unknown
Ratio of Square : round : total length	Square of top refer 59m : 62m : 121m $\cong 1 : 1 : 2$ Square of bottom refer 63m : 85m : 148m $\cong 1 : 1.3 : 2.3$	Round of top refer 21.3m : 18.7m : 40.0m $\cong 6 : 5 : 11 \cong 1 : 1 : 2$ Round of bottom refer 21.3m : 25.3m : 46.6m $\cong 1 : 1.2 : 2.2$	34m : 58m : 92m $\cong 8.5 : 14.5 : 23 \cong 1 : 1.7 : 2.7$	8.0m:14.5m:22.5m $\cong 1 : 1.8 : 2.8$
Tilt of the rear round (vs. square)	55° east	53° east	20° east	7° west
Tilt of Burial Department (vs. square)	10° left	75° left	11.5° left	7° right
Pit-type stone chamber burial part scale	Length 7m Width 2.5m Height 2-2.5m	Length 4.7m Width 1.01-1.23m Height 1.8m or more	Length 7.6m Width 2m Height 2.3m	Length 2.0m Width 0.9m Height 0.65~1.0m

4.3. Comparison of landscapes with similar keyhole tombs

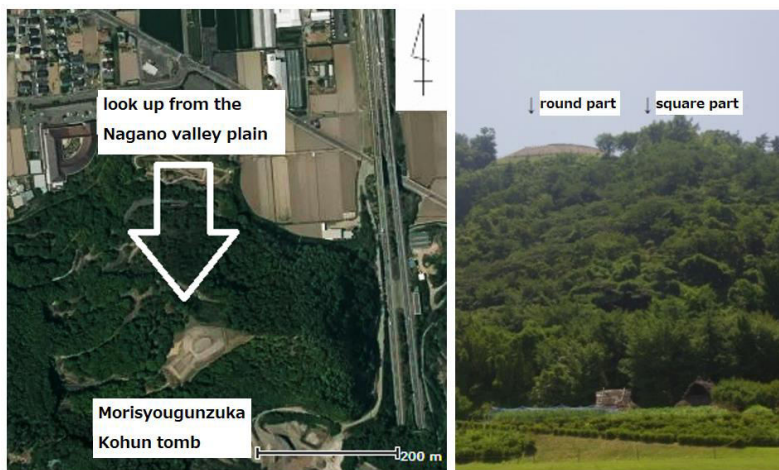

Fig.13 Location of Mori Shogunzuka tomb and landscape from the plain.

(left: Right from Yahoo map: photographed by the author)

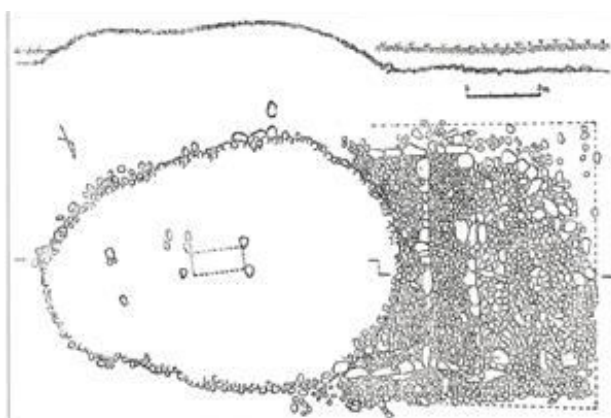

Fig.14 A plan of Unpyonri District 4 No. 6 tomb.
(from Chong 1991)

When the northern topography of Orono-shima island is considered to be "keyhole tombs facing the sea", the features are very well matched. An important element of "keyhole tombs facing the sea" is "landscape seen from the sea". In other words, the shape of the tombs as a landmark is a very important factor. The northern terrain of Orono-shima island is located on a 10m cliff at the northern end of Orono-shima Island, overlooking the Genkai-nada Sea.

The scenery seen from the sea of the northern topography of Orono-shima island will be as shown in the photograph of Figure 3 and the 3D image in Figure 4, and the rear round hill will come to the left, and the flat square part will come to the right.

of the ridge overlooking the plain, and it will be in a place addition, the rear round part often came to the left and the terrain of Orono-shima island from the sea.

country (around the BC1stc - AC 668) that existed on the keyhole tombs were built by a foreigner, the construction of cairn tomb in Japan. Then, the example of cairn tomb

in Korea is given.

The grave system of cairn tomb is found in the grave system from the early to the middle of Koukuri country, and the keyhole type-like cairn tomb was found near the border between North Korea and China, and in Jagang-do North Korea (Chong 1991).

Moreover, when it is no. 6 tomb (construction era unknown) of Unpyonri 4th district, the rear round part had a long round and an egg shape. Mori Shogunzuka Kofun is the closest in shape (See Table1). Moreover, the round part is a similar arrangement in northern terrain of Orono-shima that the round part is in the west side too. (See Fig.4.14) .

4.5 The history of keyhole tomb and cairn tomb

The Aino-shima cairn tombs group in the Genkai-nada Sea is said to have been built between the 4~7th centuries from the relics, and the Genkai-nada Sea had not been recognized as the beginning of the history of cairn tomb in Japan.

On the other hand, the northern topography of Orono-shima island has a structure common to the oldest type in the region where both cairn tomb groups exist. Therefore, it may be the founder type of Tsuruo Shrine No. 4 Kofun tomb and Mori Shogunzuka Kofun tomb. This is because this terrain is not a complete keyhole burial mound, but an incomplete type that relies heavily on natural terrain. Considering that the shape of the keyhole burial mound was adjusted in later times, the northern terrain of Orono-shima island may be a large tomb at a time when the shape of the keyhole tomb had not been shaped yet. If the Tsuruo Shrine no. 4 Kofun tomb and the Mori Shogun Tsuka Kofun tomb were built using this topography as the founder type, it might become a natural lineage (See Fig.15).

It has been pointed out that the Omuro cairn Kofun Group near the Mori Shogun zuka tumulus is also related to the Koreans (Otsuka 1993).

The cairn keyhole tombs of the Iwaseoyama Kofun Group and its pit stone chamber were separated from the ruins until then, and it can only be said that it was "suddenly" established in the Kagawa prefecture (Watanabe 1983c). In addition, there is a problem such as "The main axis of pit stone chamber in Kagawa Prefecture is mostly facing east and west, and it shows a different way of life from Kinki" (Watanabe 1983c). The above problems are solved when it is assumed that the oldest cairn tombs of this kofun group originated from the mounds of Orono-shima built by the people who conquered the Genkai Sea. Foreigners came to ancient Kagawa Prefecture, and they might build their pit-type stone chamber in the direction of their ancestors.

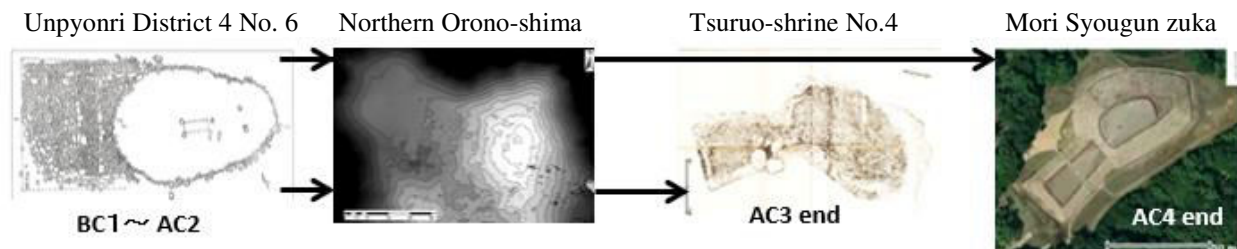

Fig.15 Expected shape change of cairn tomb from Korea to Japan

4.6 Relation to ancient emperor or Japanese mythology

If it is assumed that the people with such a grave system conquered the Genkai Sea and built cairn keyhole tomb on Orono-shima following the grave system of their hometown; and if it has since grown into a force that exerts influence throughout the country; it may unravel the mysteries of even greater ancient history. It is a relation between the ancestral myth of the Japanese emperor family and the mystery of the keyhole tomb.

Japanese mythology notes that the emperor's ancestor gods descended on Kyushu. In addition, the name of the island created by the first ancestor god is "Onogoro-shima Island". The first scene of Japanese mythology begins with the creation of an island. If this is interpreted as a story of island domination, Onogoro-shima island can be guessed as the island that the foreigners first conquered (Yamaguchi 2018·2020a).

The first island to be conquered by foreigners may have built a large tomb as a monument. And there are ruins related to the ancestor of a lot of ancient Japanese emperors older than other regions on the coast of Genkai-nada Sea. In the later days, the ancient Japanese emperor's tombs became geometric keyhole tombs.

There's still get only indirect evidence, but when we piece together these facts, we get the following guesses; "Onogoro-shima" which appears at the beginning of Japanese mythology was "Orono-shima" (Yamaguchi 2020b).

5. CONCLUSIONS



The following summarizes what the investigation revealed and the possibilities of the northern terrain of Orono-shima Island.

- 1 The northern terrain of Orono-shima Island consisted of rocks where the ground was piled up. There was also a structure like a pit stone chamber at the top. That's probably cairn type tomb.
- 2 The northern terrain of Orono-shima Island is shaped like a unique keyhole tomb, and there are a few Kofun tomb which similar one in Japan and North Korea. Especially it is very similar with the oldest keyhole tombs in Kagawa and Nagano Prefectures.
- 3 Both regions have cairn tomb groups representing Japan, and the Genkai Sea where Orono-shima is located also has Aino-shima Island, which has the second largest cairn tomb group in Japan. With the keyword cairn tombs, the three regions are deeply related.
- 4 If the northern terrain of Orono-shima island is a keyhole tomb, it is the largest in northern Kyushu. If the northern terrain of Orono-shima as a "keyhole tomb facing the sea", it is a scale like no other in remote islands. In addition, if the northern terrain of Orono-shima is a cairn type keyhole tomb, it will be the largest in Japan. It was probably a monument to the people who won this area.
- 5 The northern terrain of Orono-shima Island may be the most ancient keyhole tomb prototype, and it is highly consistent when it is considered that it was built by the Koukuri people who made North Korea their home and they developed to Japanese emperor family.
- 6 If 1-5 guesses are correct, "Orono-shima Island" could be described as the first Island in Japanese mythology which name is "Onogoro-shima". The ancient Japanese emperor's family must have created tombs that resembles the topography of this memorable island.
7. This study still faces many challenges and does not confirm that the northern terrain of Orono-shima Island is a large keyhole tomb. However, the situation evidence indicates that the hypothesis is correct. This research requires detailed laser investigation.

6 REFERENCES

- Chong Hochon, 1991. Compare with keyhole type of Koukuri cairn tomb and Japanese keyhole tomb of prototype"Keyhole: The Origin of the keyhole tombs: The Keyhole type of Koukuri cairn tomb-", Miraisha, pp.87-103 (In Japanese)
- Fukuoka City Buried Cultural Properties Division, 2019. Naka Hachiman Kofun Confirmation Survey (Naka Ruins Group 175 Next Survey) Local Meeting explanation Materials <https://bunkazai.city.fukuoka.lg.jp/files/ExcavationNewsParagraph142fileja.pdf> (In Japanese)
- Hirose Kazuo, 2009. A consideration of reconstructing our image of the Kofun period: does the period of keyhole tombs predate the Ritsuryo state?, Report on the National Museum of History and Folklore Research Report, 150, pp.33-147 (In Japanese)
- Hirose Kazuo, 2015. "The Age of The Beach-type Anterior Circular Burial Mound" (Kanagawa Archaeological Foundation) Toseisha, pp.1-36 (In Japanese)
- Kashiwagi Yoshiharu, 2015. Beach-type keyhole burial mounds in the archipelago " The age of the beach-type keyhole burial mounds " (ed., Kanagawa Archaeological Foundation) Doseisha, pp. 155-187. (In Japanese)
- Morishima Minoru, 1985. Design project of Mori Shogun Tsuka Kofun tumulus "Mori Shogunzuka Kofun Tumulus: Outline of excavations in the fifth year of preservation and maintenance project", 5, pp.21-23. (In Japanese)
- Nagano City Board of Education, 2015. "Historic Site Omuro kofun group- Japan's largest stacked Ishizuka burial mound group with mystery" (Nagano City Board of Education Cultural Properties Division Buried Cultural Property Center),pp. 1-2. (In Japanese)
- Ogata Noboru, 2019. Kofun-Ancient Burial Mounds in Japan, Soramitsu Historical-geographical tour of Nara from the air. from <http://www.hgeo.h.kyoto-u.ac.jp/soramitsu/kofun.html>
- Otsuka Hatushige, and others, 1993."Shinano Omuro Tsumiishizuka: The Study of the Stone Mounds 1" Tokyodo Publishing, pp. (In Japanese)
- Sakamoto Taro, G. Cameron Hurst, "The Yayoi period (c. 300 BCE–c. 250 CE)" History of Japan, Ancient Japan to 1185, Prehistoric Japan, Britannica web. from <https://www.britannica.com/place/Japan/History>
- Watanabe Akio, 1983a. Problems concerning of the Tsuruo Shrine No.4 burial mound "Report on the Investigation at



- the Tsuruo Shrine No. 4 Burial Mound: Investigation of the Tumiishizuka Anterior rounded Burial Mound located at Mt. Iwaseo, Takamatsu City", VII. (2), pp.60-66. (In Japanese)
- Watanabe Akio, 1983b. Problems concerning of the Tsuruo Shrine No.4 burial mound "Report on the Investigation at the Tsuruo Shrine No. 4 Burial Mound: Investigation of the Tumiishizuka Anterior rounded Burial Mound located at Mt. Iwaseo, Takamatsu City", III (1)-(5), pp.12-18. (In Japanese)
- Watanabe Akio, 1983c. Problems concerning of the Tsuruo Shrine No.4 burial mound "Report on the Investigation at the Tsuruo Shrine No. 4 Burial Mound: Investigation of the Tumiishizuka Anterior rounded Burial Mound located at Mt. Iwaseo, Takamatsu City", VII (3), pp.66-72. (In Japanese)
- Yamaguchi Tetuya, 2018."Kojiki Nihonshinwa no kokyou wa Genkai-nada no simajima datta!", Techer Onogoro series1, Dream Kingdom Editorial Department, pp.72-77.152-153. (In Japanese)
- Yamaguchi Tetuya, 2020a."Kojiki Nihonshinwa no kokyou wa Hokubu-Kyusyu datta!", Techer Onogoro series2, Dream Kingdom Editorial Department, pp.21-22. (In Japanese)
- Yamaguchi Tetuya, 2020b."Elucidation of History by Environmental Survey of Orono-Island -In Connection with Modern History and National Myths- Bulletin of the Fukuoka Institute of Technology total Research Organization report,3, pp47-56. from <https://123deta.com/document/download/zx29mjnq?page=1> (In Japanese)
- Yamaguchi Tetsuya, Ogawa Susumu, Toshiyuki Moriyama, Taniguchi Yukiya, Shiraishi Haruhiro, 2020. "Surveying and its possibility of the keyhole-tomb type topography on the Orono-Island in The Genkai Nada sea.- Compared with Orono-island topography and old type or sea side type of keyhole tomb -", The Society of Geographic Information Systems Japan 2020 Submitted papers. (In Japanese)
- Yanagisawa Kazuo, Construction trend of keyhole-burial mounds in Kyushu, University of Miyazaki Academic Information Repository, Academic Research Grant Report (Faculty of Education), pp.201-210, from https://miyazaki-u.repo.nii.ac.jp/?action=repository_uri&item_id=21 (In Japanese)
- Yanagi Takenao, 1995."Genkai-jima ni nokoru Yuriwaka densetsu", Fukuoka Historical Visit Nishi Ward, Kaityou co. pp.33-34. (In Japanese)